

SERFILCO® SERIES 'TM-SS' CENTRIFUGAL MAGNETIC COUPLED PUMPS

BULLETIN
P-516A
OCT 2004

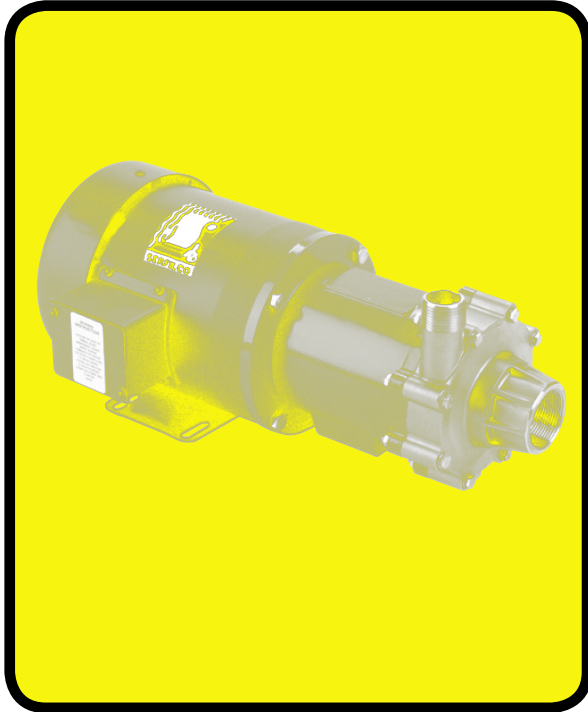

CAST 316 STAINLESS STEEL CONSTRUCTION. RUGGEDLY ENGINEERED FOR LONG TERM RELIABILITY IN DEMANDING APPLICATIONS:

***CLEANERS / SEMI-CONDUCTORS / INKS
FUME SCRUBBERS / PHOTO PROCESSING
WASTEWATER TREATMENT***

- **Flows to 160 GPM or 79 ft. TDH @ 60 Hz**
(505 LPM or 16.7m @ 50 Hz)
- **316 stainless steel construction**
Choice of EPDM or Viton® elastomers
(See a chemical resistance chart)
- **High torque magnets**
- **Massive thrust bearings**
- **Seal-less, leak-free magnetic coupled**
- **Centrifugal, quiet, vibration-free**
- **Heavy walled voluted casings**
- **For use with standard NEMA or IEC 'C'-face motors**

The Series 'TM-SS' magnetic coupled pump directly addresses the weaknesses of other magnetic drive pumps. From high torque compact magnets to a large diameter, reduced length shaft to massive precision finished thrust bearings, the 'TM-SS' pump is designed to excel where other pumps

fail. Heavy walled voluted casings improve pump strength, internal shaft support, chemical resistance, pressure and temperature capabilities as well as hydraulic efficiencies. Standard models are non-overloading with stated elevated specific gravity liquids.

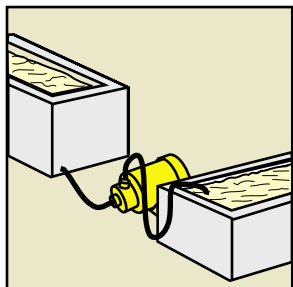

WASTE TREATMENT

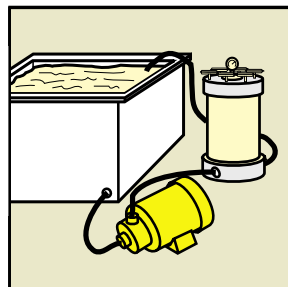

FILTRATION

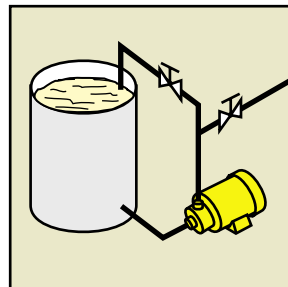

TRANSFER PUMPING

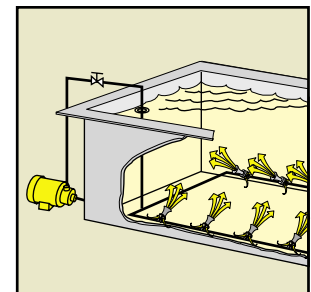

EDUCTOR AGITATION
and MIXING

SERIES 'TM-SS' PUMPS Specifications and ordering information

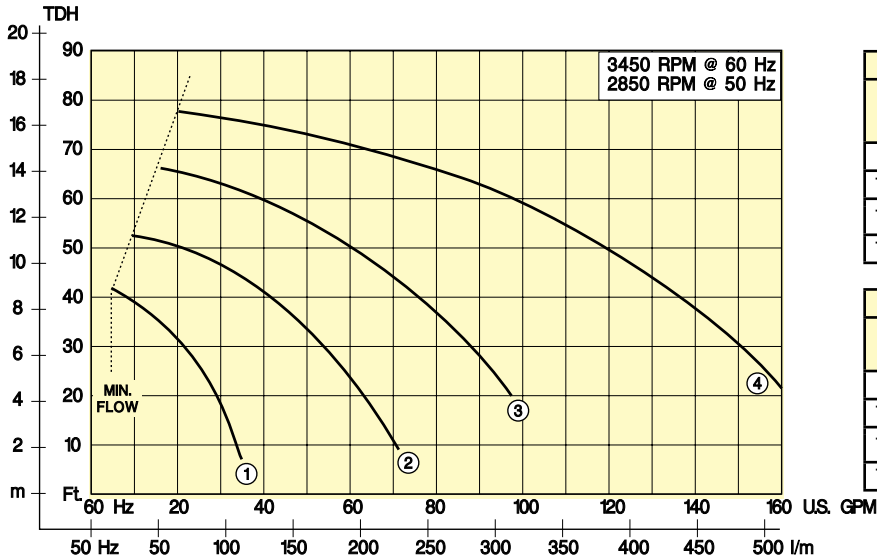

DIMENSIONS Inches				
MODEL	NEMA FRAME	A	B	C
TMSS6	56C	2-1/4	8-1/4	6-5/8
TMSS10		2-3/4	9	6-5/8
TMSS15	145TC	3-1/8	10-1/8	7-7/8
TMSS30	184TC	3-1/4	10-3/4	10-1/8

DIMENSIONS Inches				
MODEL	NEMA FRAME	D	E	F
TMSS6	56C	1-3/4	3-1/2	7
TMSS10		1-3/4	3-1/2	7-3/8
TMSS15	145TC	2-1/2	3-1/2	8-3/8
TMSS30	184TC	2-5/8	4-1/2	10

NOTE: Motor dimensions may vary.

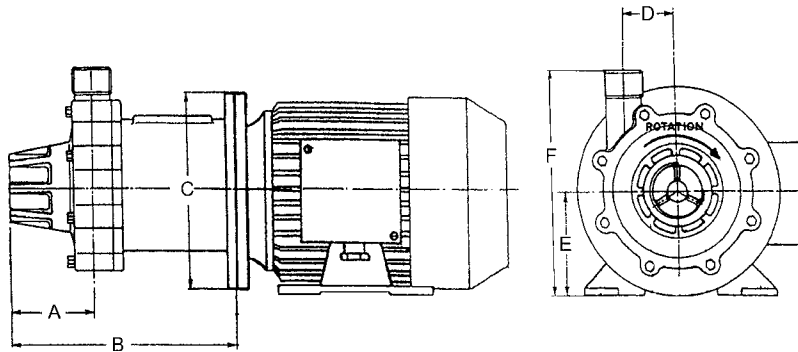

Series 'TM-SS' 316 stainless steel / Viton:

316 SS casing, impeller, shaft and rear thrust bearing, internal magnet enclosure and rear casing. Carbon filled PTFE stationary front thrust and rotating sleeve / rear thrust bearings. Viton 'O'-ring. *To order, use Price Code No. (Maximum operating temperature 300°F Maximum psi 250)*

FLOW CURVE	MAX. FLOW ¹		MAX. TDH ²		MAX. S. G. ³	HP	IMPELLER DIA.	CONNECTIONS SUCT. x DISCH.	MODEL NO.	PRICE CODE NO.	SHIPPING WT. (lbs.)
	GPM	LPM	ft.	m							
1	32	100	41	8.7	1.3	.75	3.13"	1" FNPT x 3/4" MNPT	TMSS6-3.13 D.75	51-0110	40
2	69	218	58	12.3	1.4	2.0	3.78"	1 1/2" FNPT x 1" MNPT	TMSS10-3.78 D2.0	51-0111	59
3	100	315	67	14.2	1.4	3.0	4.13"	1 1/2" FNPT x 1 1/4" MNPT	TMSS15-4.13 D3.0	51-0112	80
4	160	505	79	16.7	1.4	5.0	4.50"	2" FNPT x 1 1/2" MNPT	TMSS30-4.50 D5.0	51-0113	159

TO ORDER —

EPDM, add -L to Model No. and Price Code No.

Consult sales department for 50 Hz motors.

Motors are TEFC, 230 - 460V / 3 / 60Hz

To order 115 - 230V / 1 / 60, change **D** to **C** in Model No. and add -1 to Price Code No.

1 GPM @ 60 Hz, LPM @ 50 Hz

2 ft. TDH @ 60 Hz, m TDH @ 50Hz

3 Motors are non-overloading at stated specific gravity.

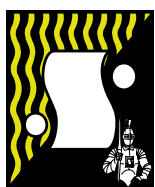

SERFILCO, LTD.

2900 MacArthur Blvd. 847-509-2900
Northbrook, IL 60062-2005 U.S.A. 800-323-5431
e-mail: sales@serfilco.com FAX: 847-559-1995
www.serfilco.com