

SERIES 'Z' CENTRIFUGAL MAGNETIC COUPLED PUMPS

**NON-METALLIC AND SEAL-LESS PUMP PROVIDING
TOTAL VAPOR AND SOLUTION CONTAINMENT FOR:**

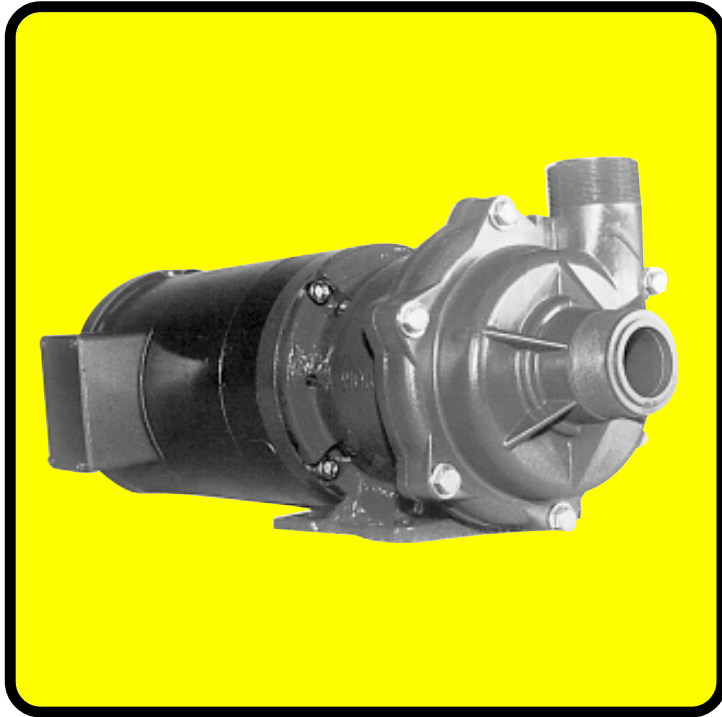

**ACID / AQUEOUS / CAUSTIC
CHEMICAL / PLATING
PHOTOGRAPHIC**

- **Flows to 145 U.S. GPM @ 60 Hz**
(548 LPM @ 50 Hz)
- **Non-metallic solution contact**
Polypropylene / Viton® or ETFE / Viton
(See a chemical resistance chart)
- **Powerful magnets**
- **Seal-less pump provides zero leakage and low friction for energy efficiency**
- **High efficiency closed impellers**

Series 'Z' Magnetic Coupled Pumps are the latest in magnetic coupled pump technology. Tested and proven design features provide a pump that is seal-less and leakproof. Available materials of construction and flow capacity to 145 U.S. GPM make this pump an excellent choice for a wide variety of applications.

Standard 'Z' models have strong magnets, allowing them to provide continuous flow with liquids up to 1.1 specific gravity. Trimmed impellers allow

continuous flow with liquids to 1.9 specific gravity. Durable and corrosion resistant construction of polypropylene or ETFE ensures efficient and reliable performance for even the most critical applications. Standard TEFC motors, strong magnets and highly efficient impellers provide a quiet and efficient pump designed for years of trouble-free operation.

The following information covers standard Series 'Z' models for use with solutions to 1.1 specific gravity. For other models consult Sales Department.

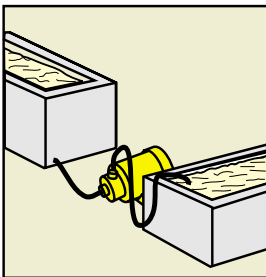

WASTE TREATMENT

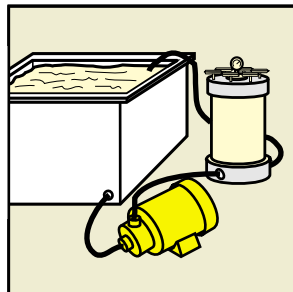

FILTRATION

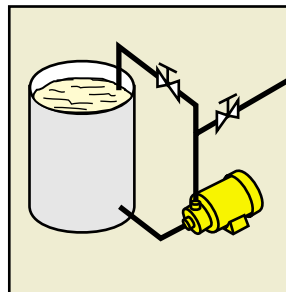

TRANSFER PUMPING

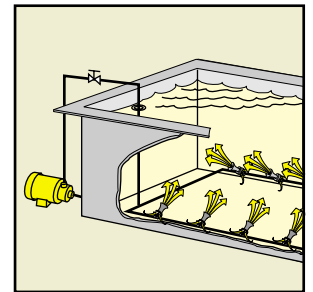

EDUCTOR AGITATION
and MIXING

SERIES 'Z' PUMPS Performance and Dimensions

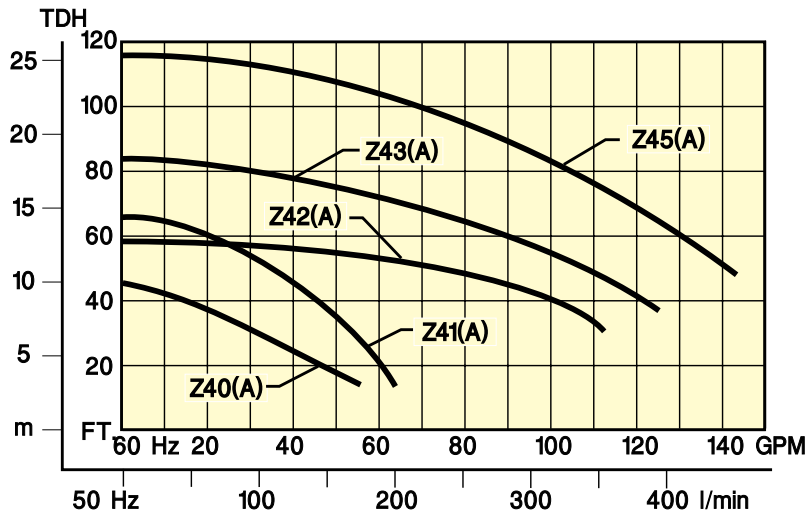

NOTE:
 3450 RPM @ 60Hz
 2850 RPM @ 50Hz
 Flows with 1.1 specific gravity.

FLOW CURVE	PORT SIZE IN x OUT (FNPT x MNPT)	PORT SIZE IN x OUT (mm)	BEST EFFICIENCY POINT (GPM @ ft.)	MAXIMUM FLOW (GPM)	MAXIMUM HEAD (ft.)	HP
Z40(A*)	1½" x 1½"	40 x 40	30 @ 30	52	44	.5
Z41(A*)	1½" x 1½"	40 x 40	40 @ 44	64	58	1.0
Z42(A*)	2" x 1½"	50 x 40	80 @ 44	110	58	2.0
Z43(A*)	2" x 1½"	50 x 40	85 @ 60	125	83	3.0
Z45(A*)	2" x 1½"	50 x 40	100 @ 86	145	115	5.0

*A series impeller for 1.1 S. G.

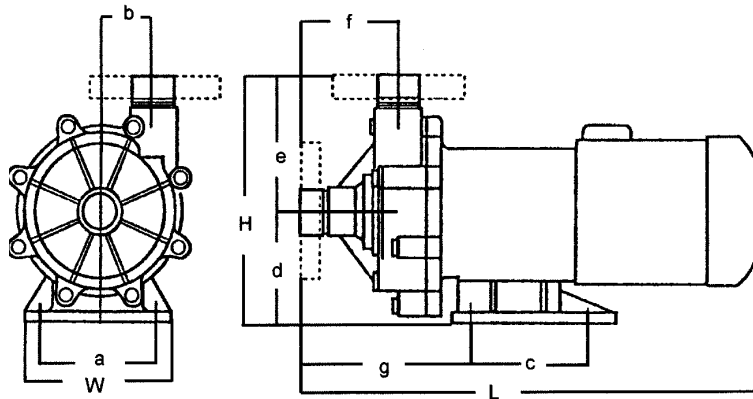

MODEL	PORT NPT		DIMENSIONS (inches)									
	IN	OUT	W	H	L**	a	b	c	d	e	f	g
Z40	1½	1½	5.52	8.33	9.12	4.33	2.01	3.86	3.78	9.87	3.28	5.77
Z41	1½	1½	6.30	9.75	19.56	5.12	2.27	5.12	4.53	10.31	3.78	6.98
Z42	2	1½	10.23	9.84	23.34	8.19	2.56	7.87	4.53	12.22	3.31	6.03
Z43	2	1½	10.23	9.84	24.22	8.19	2.56	7.87	4.53	12.22	3.31	6.03
Z45	2	1½	10.94	10.44	26.66	8.19	2.56	7.87	5.12	13.16	3.31	6.03

**Varies with motor manufacturer.

SERIES 'Z' PUMPS Ordering Information

POLYPROPYLENE PUMP and MOTOR

POLYPROPYLENE / VITON (CHCR*)

FLOW CURVE	MAX. FLOW GPM	MAX. TDH Ft.	HP / ϕ	CONNS. NPT	MODEL NUMBER	PRICE CODE NO.
Z40(A)	52	44	0.5 / 1 0.5 / 3	1½" x 1½"	Z40PV 1½T CHCR A C.5 Z40PV 1½T CHCR A D.5	82-3178 1J 82-3178 1K
Z41(A)	64	58	1.0 / 1 1.0 / 3	1½" x 1½"	Z41PV 1½T CHCR A C1.0 Z41PV 1½T CHCR A D1.0	82-4178 1N 82-4178 1P
Z42(A)	110	58	2.0 / 1 2.0 / 3	2" x 1½"	Z42PV 2T CHCR A C2.0 Z42PV 2T CHCR A D2.0	82-5188 1Q 82-5188 1R
Z43(A)	125	83	3.0 / 3	2" x 1½"	Z43PV 2T CHCR A D3.0	82-6188 1S
Z45(A)	145	115	5.0 / 3	2" x 1½"	Z45PV 2T CHCR A D5.0	82-7188 1T

POLYPROPYLENE / VITON (CCCR*)

Z40(A)	52	44	0.5 / 1 0.5 / 3	1½" x 1½"	Z40PV 1½T CCCR A C.5 Z40PV 1½T CCCR A D.5	82-317B 1J 82-317B 1K
Z41(A)	64	58	1.0 / 1 1.0 / 3	1½" x 1½"	Z41PV 1½T CCCR A C1.0 Z41PV 1½T CCCR A D1.0	82-417B 1N 82-417B 1P
Z42(A)	110	58	2.0 / 1 2.0 / 3	2" x 1½"	Z42PV 2T CCCR A C2.0 Z42PV 2T CCCR A D2.0	82-518B 1Q 82-518B 1R
Z43(A)	125	83	3.0 / 3	2" x 1½"	Z43PV 2T CCCR A D3.0	82-618B 1S
Z45(A)	145	115	5.0 / 3	2" x 1½"	Z45PV 2T CCCR A D5.0	82-718B 1T

POLYPROPYLENE / VITON (SCR*)

Z40(A)	52	44	0.5 / 1 0.5 / 3	1½" x 1½"	Z40PV 1½T SCR A C.5 Z40PV 1½T SCR A D.5	82-3179 1J 82-3179 1K
Z41(A)	64	58	1.0 / 1 1.0 / 3	1½" x 1½"	Z41PV 1½T SCR A C1.0 Z41PV 1½T SCR A D1.0	82-4179 1N 82-4179 1P
Z42(A)	110	58	2.0 / 1 2.0 / 3	2" x 1½"	Z42PV 2T SCR A C2.0 Z42PV 2T SCR A D2.0	82-5189 1Q 82-5189 1R
Z43(A)	125	83	3.0 / 3	2" x 1½"	Z43PV 2T SCR A D3.0	82-6189 1S
Z45(A)	145	115	5.0 / 3	2" x 1½"	Z45PV 2T SCR A D5.0	82-7189 1T

- Pumps good to 1.1 specific gravity.
- For heavier solutions, consult Sales Dept. for performance and operating voltage.

- TEFC, 3450 RPM, 'C' motors are 110-220V/1/60 Hz; 'D' motors are 208-230-460V/3/60 Hz.
- For 50 Hz motors, add **-5** to Model and Price Code Nos.
- For EPDM elastomers, consult Sales Department.

* FRICTION SURFACES					
MODEL	SPINDLE	REAR THRUST	FRONT THRUST	BEARING	MOUTH RING
CR	Ceramic	Ceramic	Ceramic	Rulon®	Rulon
CHCR	Ceramic	Ceramic	Ceramic	H. D. Carb.	Rulon
SCR	SiC	SiC	SiC	SiC	Rulon
CCCR	Ceramic	Ceramic	Ceramic	Ceramic	Rulon

Specifications subject to change without notice.

SERIES 'Z' PUMPS Ordering Information (cont'd)

ETFE PUMP and MOTOR

ETFE / VITON (CHCR*)

FLOW CURVE	MAX. FLOW GPM	MAX. TDH Ft.	HP / ϕ	CONNS. NPT	MODEL NUMBER	PRICE CODE NO.
Z40(A)	52	44	0.5 / 1 0.5 / 3	1½" x 1½"	Z40EV 1½T CHCR A C.5 Z40EV 1½T CHCR A D.5	82-3378 1J 82-3378 1K
Z41(A)	64	58	1.0 / 1 1.0 / 3	1½" x 1½"	Z41EV 1½T CHCR A C1.0 Z41EV 1½T CHCR A D1.0	82-4378 1N 82-4378 1P
Z42(A)	110	58	2.0 / 1 2.0 / 3	2" x 1½"	Z42EV 2T CHCR A C2.0 Z42EV 2T CHCR A D2.0	82-5388 1Q 82-5388 1R
Z43(A)	125	83	3.0 / 3	2" x 1½"	Z43EV 2T CHCR A D3.0	82-6388 1S
Z45(A)	145	115	5.0 / 3	2" x 1½"	Z45EV 2T CHCR A D5.0	82-7388 1T

ETFE / VITON (CCCR*)

Z40(A)	52	44	0.5 / 1 0.5 / 3	1½" x 1½"	Z40EV 1½T CCCR A C.5 Z40EV 1½T CCCR A D.5	82-337B 1J 82-337B 1K
Z41(A)	64	58	1.0 / 1 1.0 / 3	1½" x 1½"	Z41EV 1½T CCCR A C1.0 Z41EV 1½T CCCR A D1.0	82-437B 1N 82-437B 1P
Z42(A)	110	58	2.0 / 1 2.0 / 3	2" x 1½"	Z42EV 2T CCCR A C2.0 Z42EV 2T CCCR A D2.0	82-538B 1Q 82-538B 1R
Z43(A)	125	83	3.0 / 3	2" x 1½"	Z43EV 2T CCCR A D3.0	82-638B 1S
Z45(A)	145	115	5.0 / 3	2" x 1½"	Z45EV 2T CCCR A D5.0	82-738B 1T

ETFE / VITON (SCR*)

Z40(A)	52	44	0.5 / 1 0.5 / 3	1½" x 1½"	Z40EV 1½T SCR A C.5 Z40EV 1½T SCR A D.5	82-3379 1J 82-3379 1K
Z41(A)	64	58	1.0 / 1 1.0 / 3	1½" x 1½"	Z41EV 1½T SCR A C1.0 Z41EV 1½T SCR A D1.0	82-4379 1N 82-4379 1P
Z42(A)	110	58	2.0 / 1 2.0 / 3	2" x 1½"	Z42EV 2T SCR A C2.0 Z42EV 2T SCR A D2.0	82-5389 1Q 82-5389 1R
Z43(A)	125	83	3.0 / 3	2" x 1½"	Z43EV 2T SCR A D3.0	82-6389 1S
Z45(A)	145	115	5.0 / 3	2" x 1½"	Z45EV 2T SCR A D5.0	82-7389 1T

- Pumps good to 1.1 specific gravity.
- For heavier solutions, consult Sales Dept. for performance and operating voltage.
- TEFC, 3450 RPM, 'C' motors are 110-220V/1/60 Hz; 'D' motors are 208-230-460V/3/60 Hz.
- For 50 Hz motors, add **-5** to Model and Price Code Nos.
- For EPDM elastomers, consult Sales Department.

* FRICTION SURFACES

MODEL	SPINDLE	REAR THRUST	FRONT THRUST	BEARING	MOUTH RING
CR	Ceramic	Ceramic	Ceramic	Rulon®	Rulon
CHCR	Ceramic	Ceramic	Ceramic	H. D. Carb.	Rulon
SCR	SiC	SiC	SiC	SiC	Rulon
CCCR	Ceramic	Ceramic	Ceramic	Ceramic	Rulon

Specifications subject to change without notice.