

SERFILCO®

SERIES 'HN' HORIZONTAL PUMPS

BULLETIN
P-111A
OCT 2004



RELIABLE CORROSION-RESISTANT PUMPS FOR:

**ACID / AQUEOUS / CAUSTIC /
PLATING / SCRUBBING
WASTES AND WASTE WATER**

- **Non-metallic solution contact**
30% glass-filled Noryl®
(Refer to a chemical resistance chart)
- **To 135 U.S. GPM or 88 ft. TDH @ 60 Hz**
(425 LPM or 19 M @ 50 Hz)
- **Single mechanical seal**
carbon / silica-free ceramic
EPDM or Viton® elastomers
- **Centrifugal - quiet, vibration-free**
- **Standard NEMA C face 56J TEFC motor**
- **1½" x 1½" FNPT connections**
- **Back pull-out design, easy assembly and maintenance**

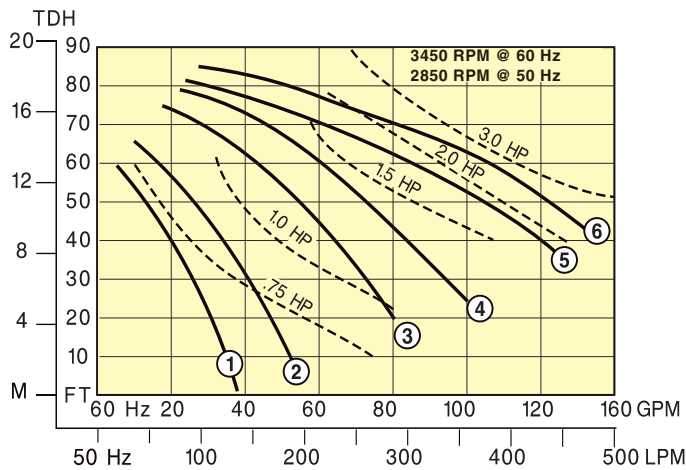

The Series 'HN' pump is capable of "total" chemical resistance, both internally and externally with its non-metallic construction of all wetted components. Engineering grade thermoplastics provide application compatibility with a variety of chemicals that would be corrosive to other materials of construction.

The totally enclosed impeller is molded to close tolerances which allow this pump to operate at peak horsepower efficiency across a broad range of operational flow/head requirements.

The unique mechanical seal eliminates any metal in contact with the solution pumped. All of these features allow this pump to properly handle many applications at a fraction of the cost of exotic alloys.

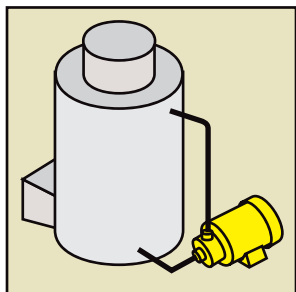

**PRESSURE
SPRAYING**

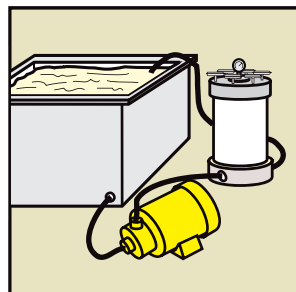

**FILTER
SYSTEM**

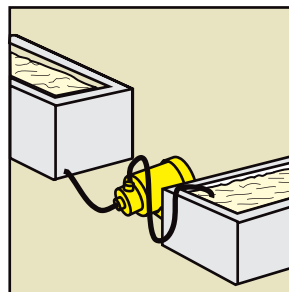

**WASTE
TREATMENT**

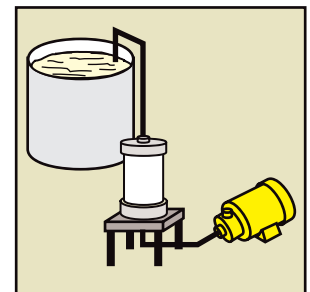

**SOLUTION TRANSFER
w/PRIMING CHAMBER**

SERIES 'HN' PUMPS Specifications and ordering Information

DIMENSIONS

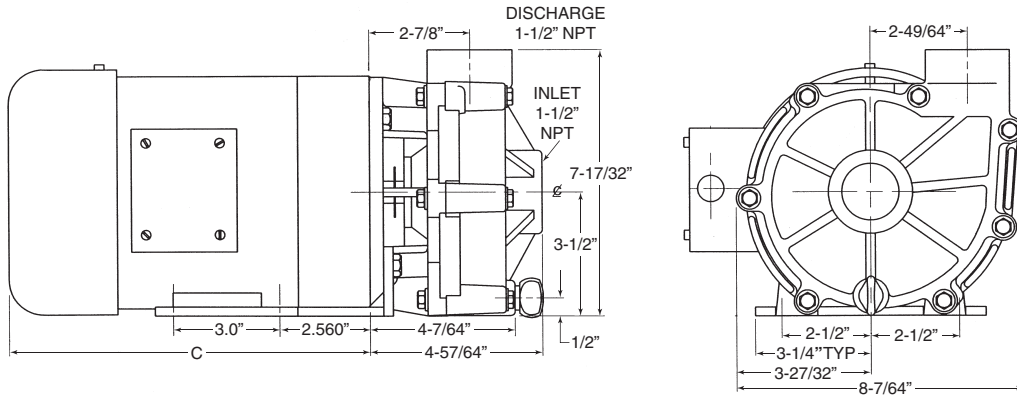

HP	Typical "C" dimensions of TEFC motor and wt. of pump / motor unit.	
	1 Phase	3 Phase
3/4	10.25" 35 lbs.	9.38" 30 lbs.
1	11.25" 44 lbs.	9.38" 33 lbs.
1.5	11.50" 49 lbs.	10.25" 35 lbs.
2	12.25" 55 lbs.	11.38" 44 lbs.
3	--	12.13" 54 lbs.

Motor dimensions may vary.

TO ORDER, use Price Code No.

TABLE I - Complete Noryl pump & motor

FLOW CURVE NO.	MAX. FLOW		MAX. TDH		EPDM - carbon / ceramic SEAL		VITON - carbon / ceramic SEAL	
	GPM @ 60 Hz	l/m @ 50 Hz	FT.	M	MODEL NO.	PRICE CODE NO.	MODEL NO.	PRICE CODE NO.
1	36	113	65	14	H1½ x 1½ NE1L(M1)-D.75	42-1011 F	H1½ x 1½ NE1V(M2)-D.75	42-1012 F
2	54	170	72	15	H1½ x 1½ NE2L(M1)-D1.0	42-1021 G	H1½ x 1½ NE2V(M2)-D1.0	42-1022 G
3	80	236	78	15	H1½ x 1½ NE3L(M1)-D1.5	42-1031 H	H1½ x 1½ NE3V(M2)-D1.5	42-1032 H
4	100	308	84	18	H1½ x 1½ NE4L(M1)-D1.5	42-1041 H	H1½ x 1½ NE4V(M2)-D1.5	42-1042 H
5	124	390	85	18	H1½ x 1½ NE5L(M1)-D2.0	42-1051 J	H1½ x 1½ NE5V(M2)-D2.0	42-1052 J
6	135	425	88	19	H1½ x 1½ NE6L(M1)-D3.0	42-1061 K	H1½ x 1½ NE6V(M2)-D3.0	42-1062 K

NOTE: Motors are 230-460V / 3 / 60 Hz. See Table II for 1 and / or other HP

TABLE II - Select pump components

EXAMPLE: Model H1½ x 1½ Material N Impeller E Curve 3 Seal V(M2) Motor = -C1.5 Price Code No. 42-1032 C

PUMP		MAT'L of CONSTRUCTION		IMPELLER TYPE		FLOW CURVE	SEAL		HP	MOTOR 115-230V / 1 / 60		MOTOR 230-460V / 3 / 60	
MODEL	PCN	MODEL	PCN	MODEL	PCN	MOD. & PCN	MODEL	PCN		MODEL TEFC	PRICE CODE	MODEL TEFC	PRICE CODE
H1½ x 1½ Horizontal 1½ x 1½ FTPT connections	42-	N	1	E	0	1	L (M1)	1	.75	-C.75	A	-D.75	F
						2	EPDM	1	1.0	-C1.0	B	-D1.0	G
						3	Carb./ ceramic	1	1.5	-C1.5	C	-D1.5	H
						4	V (M2) Viton	2	2.0	-C2.0	D	-D2.0	J
						5			3.0	-C3.0	E	-D3.0	K
						6			Carb. / ceramic				

Consult Sales Dept. for 50 Hz or other motors.

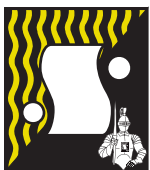

SERFILCO, LTD.

2900 MacArthur Blvd Northbrook, IL 60062-2005 U.S.A.
e-mail: sales@serfilco.com www.serfilco.com
847-509-2900 800-323-5431 FAX: 847-559-1995